

Autonics High Accuracy PID Temperature Controller TK4 SERIES

INSTRUCTION MANUAL



Thank you for choosing our Autonics product.
Please read the following safety considerations before use.

Safety Considerations

⚠ Please observe all safety considerations for safe and proper product operation to avoid hazards.
⚠ symbol represents caution due to special circumstances in which hazards may occur.

Warning Failure to follow these instructions may result in serious injury or death.
Caution Failure to follow these instructions may result in personal injury or product damage.

Warning

- Fail-safe device must be installed when using the unit with machinery that may cause serious injury or substantial economic loss.** (e.g. nuclear power control, medical equipment, ships, vehicles, railways, aircraft, combustion apparatus, safety equipment, crime/disaster prevention devices, etc.) Failure to follow this instruction may result in fire, personal injury, or economic loss.
- Install on a device panel to use.** Failure to follow this instruction may result in electric shock.
- Do not connect, repair, or inspect the unit while connected to a power source.** Failure to follow this instruction may result in electric shock or fire.
- Check "Connections" before wiring.** Failure to follow this instruction may result in fire.
- Do not disassemble or modify the unit.** Failure to follow this instruction may result in electric shock or fire.

Caution

- When connecting the power input and relay output, use AWG 20 (0.50mm²) cable or over and tighten the terminal screw with a tightening torque of 0.74-0.90Nm.**
When connecting the sensor input and communication cable without dedicated cable, use AWG 28-26 cable or over and tighten the terminal screw with a tightening torque of 0.74-0.90Nm. Failure to follow this instruction may result in fire or malfunction due to contact failure.
- Use the unit within the rated specifications.** Failure to follow this instruction may result in fire or product damage.
- Use dry cloth to clean the unit, and do not use water or organic solvent.** Failure to follow this instruction may result in electric shock or fire.
- Do not use the unit in the place where flammable/explosive/corrosive gas, humidity, direct sunlight, radiant heat, vibration, impact, or salinity may be present.** Failure to follow this instruction may result in fire or explosion.
- Keep metal chip, dust, and wire residue from flowing into the unit.** Failure to follow this instruction may result in fire or product damage.

Ordering Information

TK	4	N	-1	4	R	N
OUT2 control output ²⁾	Standard	N	None	※ Select in case of standard control (heating or cooling)		
OUT1 control output ²⁾	Heating & Cooling	R	Relay output			
Power supply	S ⁴⁾	C	Current output or SSR drive output selectable			
	2 ⁵⁾	4	100-240VAC 50/60Hz			
	1	2	Standard	Alarm output 1+CT input ¹⁾		
	N	D	Standard	Alarm output 1+Alarm output 2		
	R	T	Standard	Alarm output 1+Digital input (DI-1, DI-2)		
	S	M	Standard	Alarm output 1+Transmission output		
	W	L	Standard	Transmission output		
	H	D	Standard	Alarm output 1+RS485 communication output		
	M	S	Standard	RS485 communication output		
	W	S	Standard	Alarm output 1		
	H	R	Standard	Alarm output 1+Alarm output 2		
	L	A	Standard	Alarm output 1+Transmission output		
	4	B	Standard	Alarm output 1+Alarm output 2+RS485 communication output		
	N	D	Standard	Alarm output 1+Alarm output 2+Digital input (DI-1, DI-2) ¹⁾		
	SP	N	DIN W48xH24mm			
	S	SP	DIN W48xH48mm (11pin plug type) ¹⁾			
	M	S	DIN W48xH48mm (terminal block type)			
	W	M	DIN W72xH72mm			
	H	W	DIN W96xH48mm			
	L	H	DIN W48xH96mm			
	4	L	DIN W96xH96mm			
	TK	4	9999 (4-digit)			
Item	TK	Temperature / Process Controller				

- In case of TK4N/SP Series, option control selection and digital input will be limited due to number of terminals.
- "S" represents SSR drive output support models which SSR function (standard ON/OFF, cycle, phase) control are available. "C" represents selectable current and SSR drive output support models.
- Select "R" or "C" type in case of using heating/cooling control and "N" type in case of using standard control.
- Does not support in AC/DC voltage type model.
- Does not support in TK4N.
- The CT input model of TK4N is selectable only for standard model which has alarm output 1.
- The heating/cooling model of TK4N-1□□□ has only alarm output 2.
- Only for TK4S-□□□□, OUT2 output terminal is used as DI-2 input terminal.
- 11Pin socket (PG-11, PS-11(N)) for TK4SP: sold separately.

※ Shaded descriptions are upgraded or added functions from the before TK Series.
※ The above specifications are subject to change and some models may be discontinued without notice.
※ Be sure to follow cautions written in the instruction manual, user manual and the technical descriptions (catalog, homepage).

Specifications

Series	TK4N	TK4SP	TK4S	TK4M	TK4W	TK4H	TK4L
Power supply	AC voltage	100-240VAC~50/60Hz	—	24VAC~50/60Hz, 24-48VDC=	—	—	—
Allowable voltage range	AC voltage	90 to 110% of rated voltage	—	—	—	—	—
Power consumption	AC/DC voltage	Max. 6VA	Max. 8VA	Max. 8VA (24VAC 50/60Hz), max. 5W (24-48VDC)	—	—	—
Display method	7-segment (PV: red, SV: green, other display part (green, yellow, red) LED method						
Character size	PV (W×H)	4.5×7.2mm	7.0×14.0mm	9.5×20.0mm	8.5×17.0mm	7.0×14.6mm	11.0×22.0mm
	SV (W×H)	3.5×5.8mm	5.0×10.0mm	7.5×15.0mm	6.0×12.0mm	6.0×12.0mm	7.0×14.0mm
Input type	RTD	JPT 100Ω, DPT 100Ω, DPT 50Ω, Cu 100Ω, Cu 50Ω, NiKel 120Ω (6 types)					
	Thermocouple	K, J, E, T, L, N, U, R, S, B, C, G, PLII (13 types)					
	Analog	Voltage: 0-100mVDC=, 0-5VDC=, 1-5VDC=, 0-10VDC= (4 types) Current: 0-20mA, 4-20mA (2 types)					
Display accuracy	RTD	At room temperature (23°C ±5°C): (PV ±0.3% or ±1°C, select the higher one) ±1-digit ¹⁾ Out of room temperature ranges: (PV ±0.5% or ±2°C, select the higher one) ±1-digit In case of TK4SP Series, ±1°C will be added.					
	Thermocouple	At room temperature (23°C ±5°C): ±0.3% F.S. ±1-digit Out of room temperature ranges: ±0.5% F.S. ±1-digit					
	Analog	CT input ±5% F.S. ±1-digit					
Control output	Relay	OUT1, OUT2: 250VAC~3A, 30VDC=3A, 1a					
	SSR	Max. 11VDC±2V 20mA					
	Current	DC4-20mA or DC0-20mA selectable (resistance load: max. 500Ω)					
Alarm output ¹⁾	Relay	AL1, AL2: 250VAC~3A 1a ※TK4N AL2: 250VAC~0.5A, 1a (max. 125VA), TK4SP has only AL1					
Option output	Transmission	DC4-20mA (resistance load: max. 500Ω, output accuracy: ±0.3% F.S.)					
	Communication	RS485 communication output (Modbus RTU)					
	CT	0.0-50.0A (primary heater current reading range) ※CT ratio is 1/1000 (except TK4SP)					
Option input	Digital input	Contact input: ON - max. 2kΩ, OFF - min. 90kΩ Non-contact input: ON - residual voltage max. 1.0VDC=, OFF - leakage current max. 0.1mA Outflow current: approx. 0.5mA per input ※TK4SM: 1 (TK4S-□□□□), 2 (TK4SP: none), TK4NH/H/L: 2 (except TK4SP)					
Control method	Heating, Cooling	ON/OFF, P, PI, PD, PID control mode					
	Heating&Cooling						
Hysteresis	RTD/Thermocouples:	1 to 100°C/°F (0.1 to 100.0°C/°F) variable - Analog: 1 to 100-digit					
Proportional band (P)		0.1 to 999.9°C/°F (0.1 to 999.9%)					
Integral time (I)		0 to 9999 sec					
Derivative time (D)		0 to 9999 sec					
Control period (T)	Relay output, SSR drive output:	0.1 to 120.0 sec					
	Current output+SSR drive output:	1.0 to 120.0 sec					
Manual reset value		0.0 to 100.0%					
Sampling period		50ms					
Dielectric strength		2,000VAC 50/60Hz for 1 min (between power source terminal and input terminal)					
Vibration		0.75mm amplitude at frequency of 5 to 55Hz (for 1 min) in each X, Y, Z direction for 2 hours					
Relay life cycle	Mechanical	OUT1/OUT2: min. 5,000,000 operations, AL1/AL2: min. 20,000,000 operations (TK4H/H/L: min. 5,000,000 operations)					
	Electrical	OUT1/OUT2, AL1/AL2: min. 100,000 operations					
Insulation resistance		Over 100MΩ (at 500VDC megger)					
Noise immunity		Square shaped noise by noise simulator (pulse width 1μs) ±2kV R-phase, S-phase					
Memory retention		Approx. 10 years (non-volatile semiconductor memory type)					
Environment	Ambient temp.	-10 to 50°C, storage: -20 to 60°C					
	Ambient humi.	35 to 85%RH, storage: 35 to 85%RH					
Protection		IP65 (front panel) ※TK4SP: IP50 (front panel) Double insulation or reinforced insulation (mark: □, dielectric strength between the measuring input part and the power part: 2kV)					
Insulation type							
Approval		CE, RoHS					
Weight ¹⁾	Approx. 140g	Approx. 130g	Approx. 150g	Approx. 210g	Approx. 211g	Approx. 294g	Approx. 196g
	(approx. 70g)	(approx. 85g)	(approx. 105g)	(approx. 140g)	(approx. 141g)	(approx. 196g)	(approx. 196g)

- At room temperature range (23°C±5°C):
 - Thermocouple K, J, T, N, E type, below -100°C / Thermocouple L, U, PLII, Cu50Ω, DPT 50Ω: (PV ±0.3% or ±2°C, select the higher one) ±1-digit
 - Thermocouple C, G, R, S type, below 200°C: (PV ±0.3% or ±3°C, select the higher one) ±1-digit
 - Thermocouple B type, below 400°C: there is no accuracy standards.
 - Out of room temperature range
 - RTD Cu50Ω, DPT50Ω: (PV ±0.5% or ±3°C, select the higher one) ±1-digit
 - Thermocouple R, S, B, C, G type: (PV ±0.5% or ±5°C, select the higher one) ±1-digit
 - Others, below -100°C: within ±5°C
- In case of TK4SP Series, ±1°C will be added to the degree standard.
※ The weight includes packaging. The weight in parenthesis is for unit only.
※ Environment resistance is rated at no freezing or condensation.

Unit Description

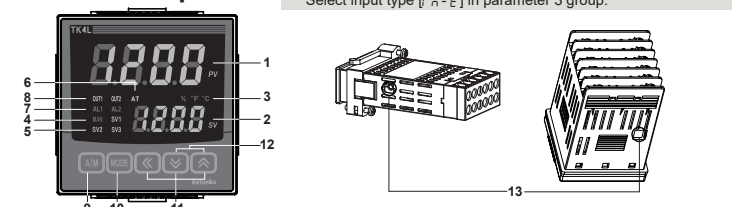

- Measured value (PV) display part:** RUN mode: It displays currently measured value (PV). Setting mode: It displays the parameter.
- Set value (SV) display part:** RUN mode: It displays the set value (SV). Setting mode: It displays the set value of the parameter.
- Unit (%C/F%) indicator:** It displays the unit set at display unit [unit] in parameter 3 group. (In case of TK4N, % is not supported).
- Manual control indicator:** It turns ON during manual controlling.
- Auto SV indicator:** One of SV1 to 3 lamps will be ON in case of selecting multi SV function.
- Auto tuning indicator:** It flashes by 1 sec. when executing auto tuning.
- Alarm output (AL1, AL2) indicator:** It turns ON when the alarm output is ON.
- Control output (OUT1, OUT2) indicator:** It turns ON when the control output is ON.
 - ※ During cycle/phase controlling in SSRP function model (TK4□□4S□□), when MV is over 5.0%, it turns ON.
 - ※ To use current output, when MV is 0.0% in manual control, it turns OFF. Otherwise, it always turns ON.
 - When MV is over 3.0% in auto control, it turns ON and when MV is below 2.0%, it turns OFF.
- Key:** It is used when switching auto control to manual control.
- TK4N/S/SP** do not have the **key**. The **key** operates switching simultaneously.
- key:** It is used when entering parameter groups, returning to RUN mode, moving parameter, saving the set value.
- key:** It is used when entering the set value changing mode and moving or changing up/down digit.
- Digital input key:** When pressing **key** + **key** for 3 sec. at the same time, it operates the function (RUN/STOP, alarm clear, auto tuning) set at digital input key [di - v] in parameter 5 group.
- PC loader port:** It is the PC loader port for serial communication to set parameter with DAQMaster installed in PC. Use this for connecting SCM-US (USB/Serial converter, sold separately).

Installation

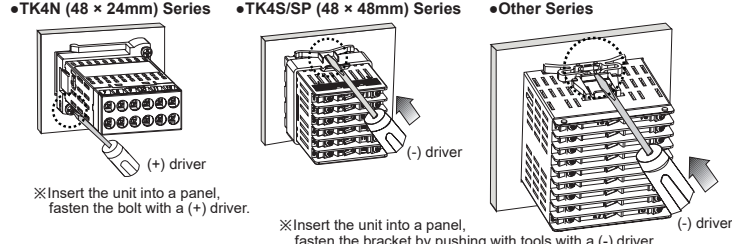

Connections

※ Standard model has shaded terminals only.
※ When the operation mode of heating&cooling OUT2 relay output model is heating or cooling control, the OUT2 is usable as alarm output 3 (except TK4N Series).
※ When the operation mode of heating&cooling OUT2 current output model is heating or cooling control, the OUT2 is usable as transmission output 2.
※ Use terminals of size specified below.

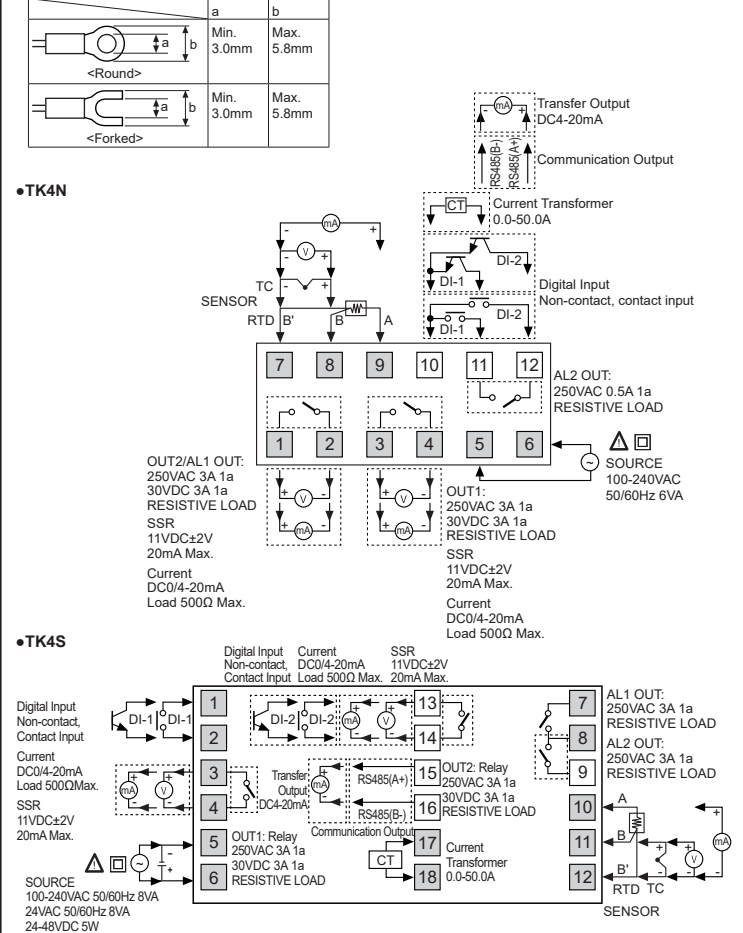

Dimensions

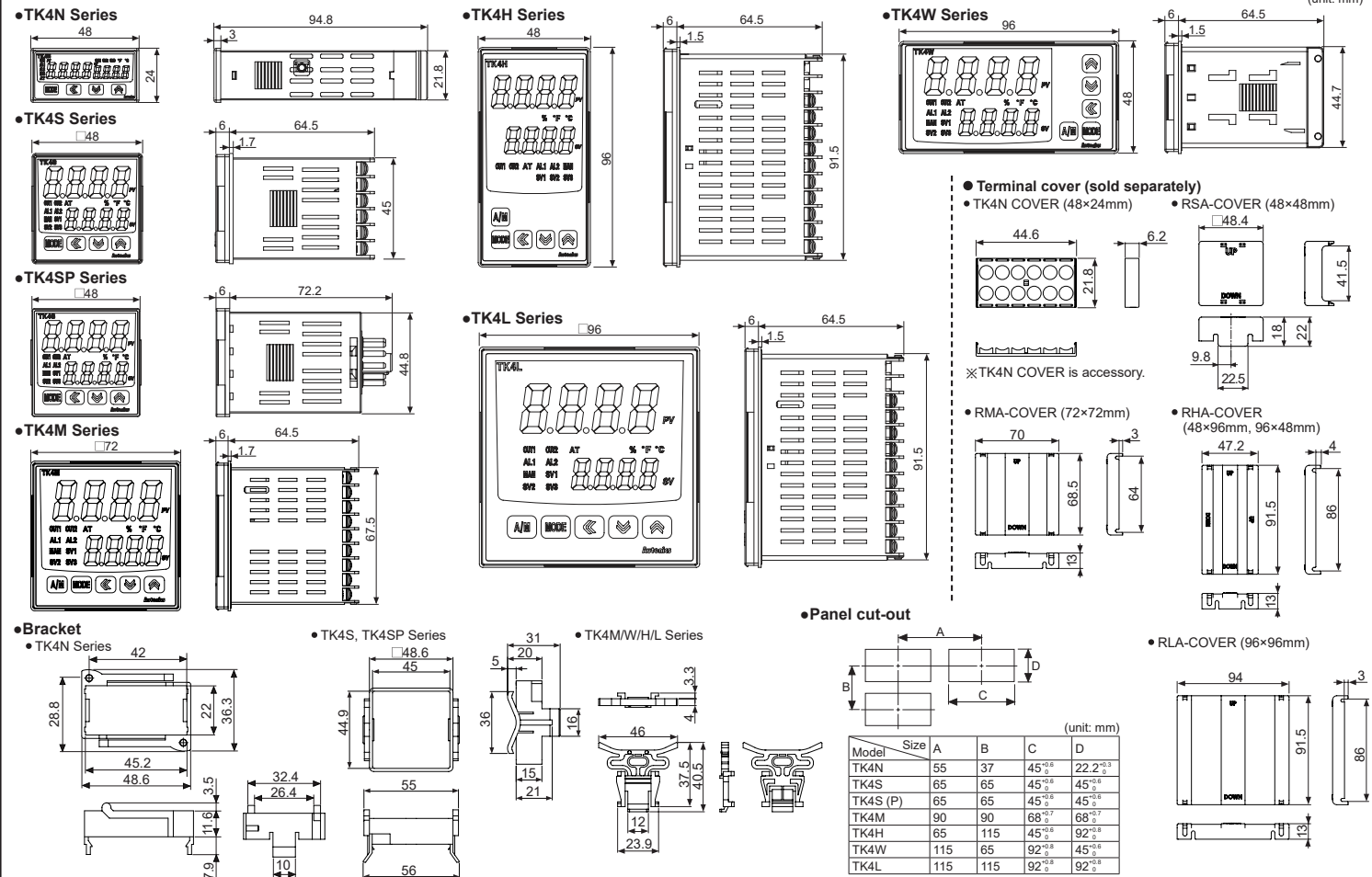

Flow Chart for Setting Group

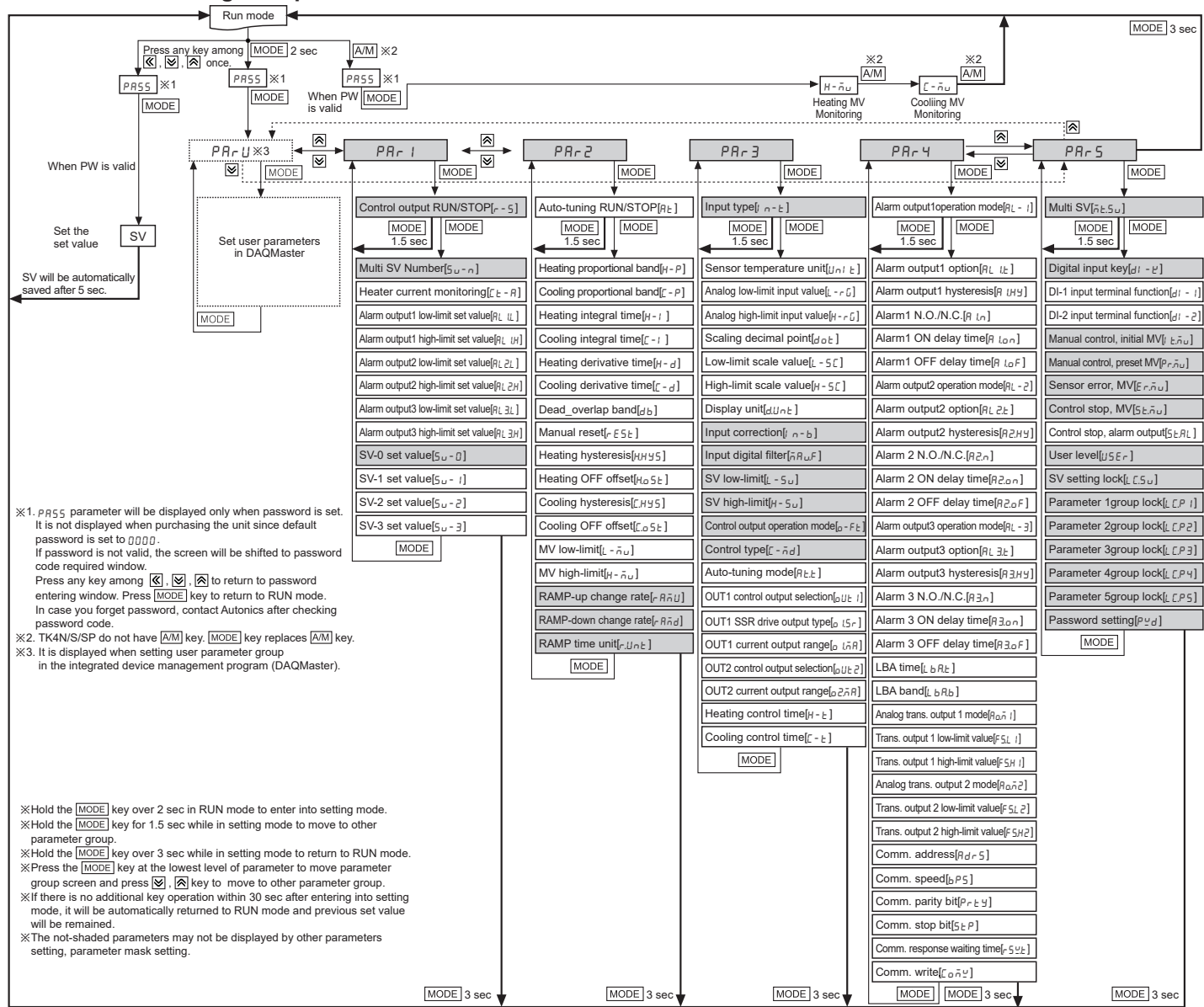

※1. PR55 parameter will be displayed only when password is set. It is not displayed when purchasing the unit since default password is set to 0000. If password is not valid, the screen will be shifted to password code required window. Press any key among [OK], [MODE], [AM] to return to password entering window. Press [MODE] key to return to RUN mode. In case you forget password, contact Autonics after checking password code.

※2. TK4N/SP do not have [AM] key. [MODE] key replaces [AM] key.

※3. It is displayed when setting user parameter group in the integrated device management program (DAQMaster).

※Hold the [MODE] key over 2 sec in RUN mode to enter into setting mode.

※Hold the [MODE] key for 1.5 sec while in setting mode to move to other parameter group.

※Hold the [MODE] key over 3 sec while in setting mode to return to RUN mode.

※Press the [MODE] key at the lowest level of parameter to move parameter group screen and press [OK], [AM] key to move to other parameter group.

※If there is no additional key operation within 30 sec after entering into setting mode, it will be automatically returned to RUN mode and previous set value will be remained.

※The not-shaded parameters may not be displayed by other parameters setting, parameter mask setting.

Input Types and Range

Input type	Decimal point	Display	Input range (°C)	Input range (°F)
Thermocouple	K (CA)	1	-200 to 1350	-328 to 2463
	J (IC)	0.1	-199.9 to 999.9	-328 to 1472
	E (CR)	0.1	-199.9 to 800.0	-328 to 1472
	T (CC)	1	-200 to 400	-328 to 752
	B (PR)	1	-199.9 to 999.9	-328 to 1850
	R (PR)	1	-199.9 to 999.9	-328 to 1850
	S (PR)	1	-199.9 to 999.9	-328 to 1850
	N (NN)	1	-200 to 1300	-328 to 2372
	C (TT) ^{※1}	1	0 to 2300	32 to 4172
	G (TT) ^{※2}	1	0 to 2300	32 to 4172
RTD	L (IC)	0.1	-200 to 900	-328 to 1652
	U (CC)	0.1	-199.9 to 900.0	-328 to 1652
	Platine II	1	-199.9 to 400.0	-328 to 752.0
	Cu 50Ω	0.1	-199.9 to 200.0	-328 to 392.0
	Cu 100Ω	0.1	-199.9 to 200.0	-328 to 392.0
	JPT 100Ω	0.1	-199.9 to 650.0	-328 to 1202
	DPT 50Ω	0.1	-199.9 to 650.0	-328 to 1202
	DPT 100Ω	0.1	-199.9 to 650.0	-328 to 1202
	Nickel 120Ω	0.1	-199.9 to 650.0	-328 to 1202
	Analog	Voltage	0-10V	-1999 to 9999
0-5V		-1999 to 9999		
1-5V		-1999 to 9999		
0-100mV		-1999 to 9999		
Current	0-20mA	-1999 to 9999		
4-20mA	-1999 to 9999			

※1: C (TT): Same temperature sensor as former W5 (TT)
 ※2: G (TT): Same temperature sensor as former W (TT)

Initial Display When Power ON

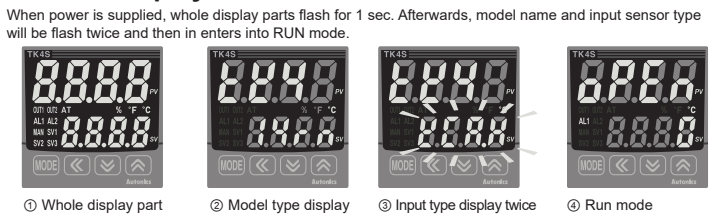

Set Value (SV) Setting

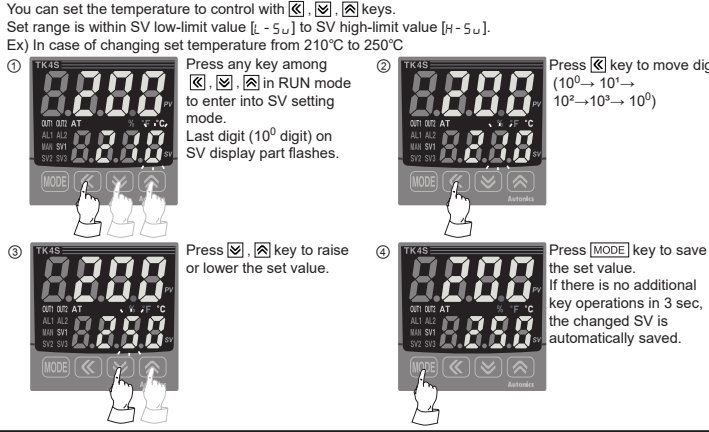

Parameter Reset

Press [OK] + [MODE] + [AM] to reset all parameters in memory to default value. Set [n1] parameter to '4E5' to reset all parameters. In case password function is on, it is required to enter valid password to reset parameters. Password is also reset.

Parameter Mask

This function is able to hide unnecessary parameters to user environment or less frequently used parameters in parameter group. You can set this in the integrated device management program (DAQMaster). Masked parameters are not only displayed. The set value of masked parameters are applied. For more information, refer to the DAQMaster user manual. Visit our website (www.autonics.com) to download the DAQMaster program and the user manual.

Before applying mask: PR-2 → RL → H-P → C-P → H-I → C-I → H-d → C-d

After applying mask: PR-2 → H-P → H-I → H-d

The above is masking auto tuning [n1], cooling proportional band [c-p], cooling integral time [c-i], cooling derivative time [c-d] parameters in parameter 2 group.

User Parameter Group [PR-U] Setting

This function is able to set the frequently used parameters to the user parameter group. You can quickly and easily set parameter settings. User parameter group can have up to 30 parameters in the integrated device management program (DAQMaster). For more information, refer to the DAQMaster user manual. Visit our website (www.autonics.com) to download the DAQMaster program and the user manual.

Run mode: PR-U → PR-1 → PR-2

RL → RL → SV-0 → HHYS → CHYS → In-b → RHYS → RHYS

The above is setting user parameter group in the DAQMaster with alarm output 1 low-limit value [RL], alarm output 1 high-limit value [RL], SV-0 set value [SV-0] parameter of parameter 1 group, heating hysteresis [HHYS], cooling hysteresis [CHYS] parameters of parameter 2 group, input correction [In-b] parameter of parameter 3 group, alarm output 1 hysteresis [RHYS], alarm output 2 hysteresis [RHYS] parameters of parameter 4 group.

Auto-tuning

Auto-tuning measures the control subject's thermal characteristics and thermal response rate, and then determines the necessary PID time constant. Application of the PID time constant realizes fast response and high precision temperature control. (When setting control type [c-d] is set as P, it is displayed.) Set [n1] parameter to [n1] in parameter 2 group to start auto-tuning. To stop auto-tuning, change the set as [oFF]. (It maintains P, I, D values of before auto-tuning.) If sensor break error [bPE] occurs during auto-tuning, it stops this operation. If the measured temperature is over or below the input range, it operates continuously. During auto-tuning operation, whole parameters are only available to check.

Alarm

Mode	Name	Alarm operation	Description
oFF	—	—	No alarm output
dUCC	Deviation high-limit alarm	OFF H ON SV PV 100°C 110°C High deviation: Set as 10°C High deviation: Set as -10°C	If deviation between PV and SV as high-limit is higher than set value of deviation temperature, the alarm output will be ON.
JJdU	Deviation low-limit alarm	ON H OFF PV SV 90°C 100°C Low deviation: Set as 10°C Low deviation: Set as -10°C	If deviation between PV and SV as low-limit is higher than set value of deviation temperature, the alarm output will be ON.
JdUc	Deviation high/low-limit alarm	ON H OFF H ON PV SV PV SV 90°C 100°C 120°C Low deviation: Set as 10°C, High deviation: Set as 20°C	If deviation between PV and SV as high/low-limit is higher than set value of deviation temperature, the alarm output will be ON.
CdUJ	Deviation high/low-limit alarm	OFF H ON H OFF PV SV PV SV 90°C 100°C 120°C Low deviation: Set as 10°C, High deviation: Set as 20°C	If deviation between PV and SV as high/low-limit is lower than set value of deviation temperature, the alarm output will be OFF.
PuCC	Absolute value high-limit alarm	OFF H ON H ON PV SV PV SV 90°C 100°C 110°C Absolute-value: Set as 90°C Absolute-value: Set as 110°C	If PV is higher than the absolute value, the output will be ON.
JJPu	Absolute value low-limit alarm	ON H OFF H OFF PV SV PV SV 90°C 100°C 110°C Absolute-value: Set as 90°C Absolute-value: Set as 110°C	If PV is lower than the absolute value, the output will be ON.
LbR	Loop break alarm	—	It will be ON when it detects loop break.
5bR	Sensor break alarm	—	It will be ON when it detects sensor disconnection.
HbR	Heater break alarm	—	It will be ON when CT detects heater break.

※H: Alarm output □ hysteresis [RHYS]

Mode	Name	Description
RL - A	Standard alarm	If it is an alarm condition, alarm output is ON. If it is a clear alarm condition, alarm output is OFF.
RL - b	Alarm latch	If it is an alarm condition, alarm output is ON and maintains ON status.
RL - c	Standby sequence 1	First alarm condition is ignored and from second alarm condition, standard alarm operates. When power is supplied and it is an alarm condition, this first alarm condition is ignored and from the second alarm condition, standard alarm operates.
RL - d	Alarm latch and standby sequence 1	If it is an alarm condition, it operates both alarm latch and standby sequence. When power is supplied and it is an alarm condition, this first alarm condition is ignored and from the second alarm condition, alarm latch operates.
RL - E	Standby sequence 2	First alarm condition is ignored and from second alarm condition, standard alarm operates. When re-applied standby sequence and if it is alarm condition, alarm output does not turn ON. After clearing alarm condition, standard alarm operates.
RL - F	Alarm latch and standby sequence 2	Basic operation is same as alarm latch and standby sequence 1. It operates not only by power ON/OFF, but also alarm set value, or alarm option changing. When re-applied standby sequence and if it is alarm condition, alarm output does not turn ON. After clearing alarm condition, alarm latch operates.

※Condition of re-applied standby sequence for standby sequence 1, alarm latch and standby sequence 1: Power ON
 Condition of re-applied standby sequence for standby sequence 2, alarm latch and standby sequence 2: Power ON, changing set temperature, alarm temperature [RL 1, RL 2] or alarm operation [RL - 1, RL - 2], switching STOP mode to RUN mode.

Factory Default

Parameter	Factory default	Parameter	Factory default	Parameter	Factory default	Parameter	Factory default
SV	0	PR55	0001				
Parameter 1 group [PR-1]							
r-5	rUn	RL LH	1550	RL 3H	1550	SV-3	0000
SV-n	SV-0	RL 2L	1550	SV-0	0000		
Ct-A	00	RL 2H	1550	SV-1	0000		
RL LL	1550	RL 3L	1550	SV-2	0000		
Parameter 2 group [PR-2]							
RLt	oFF	H-d	0000	Ho5t	000	rARU	000
H-P	0.100	C-d	0000	CHYS	002	rARd	000
C-P	0.100	db	0000	Co5t	000	rARt	n1 n
H-I	0000	rE5t	0500	L-nu	-1000		
C-I	0000	HHYS	002	H-nu	1000		
Parameter 3 group [PR-3]							
In-t	ECRH	H-5C	1000	o-Ft	HEAt	o15r	5tnd
Un1t	oC	dUn1t	o'0	o-Ft	H-C	o1AR	4-20
L-rG	0000	In-b	0000	C-n1d	P1d	oUe2	CUr
H-rG	1000	nARuF	0001	PP	o2AR	4-20	
d-oE	00	L-5u	-200	RLt	tUn1	H-t	0200 (Relay)
L-5C	0000	H-5u	1350	oUe1	CUrr	C-t	0020 (SSR)
Parameter 4 group [PR-4]							
RL-1	dUCC	RL2n	no	LbRt	0000	bP5	95
RL LH	RL-A	RL2on	0000	LbRb	002	Pr-y	noAE
RL UY	001	RL2oF	0000	RoAn1	Pu	5tP	2
RL In	no	RL-3	oFF	F5L1	-200	r54t	20
RL on	0000	RL3t	RL-A	F5H1	1350	CoNy	EnR
RL oF	0000	RL3Y	001	RoAn2	Pu		
RL-2	JJdU	RL3n	no	F5L2	-200		
RL 2t	RL-A	RL3on	0000	F5H2	1350		
RL2Hy	001	RL3oF	0000	Rd-r5	01		

※Shaded parameters are for the heating&cooling model.

User Manual

For the detail information and instructions, please refer to user manual and user manual for communication, and be sure to follow cautions written in the technical descriptions (catalog, homepage). Visit our homepage (www.autonics.com) to download manuals.

Comprehensive Device Management Program[DAQMaster]

DAQMaster is a comprehensive device management software for setting parameters and monitoring processes. DAQMaster can be downloaded from our website at www.autonics.com.

Item	Minimum specifications
System	IBM PC compatible computer with Pentium III or above
Operations	Windows 98/NT/XP/Vista/7/8/10
Memory	256MB+
Hard disk	1GB+ of available hard disk space
VGA	Resolution: 1024×768 or higher
Others	RS232C serial port (9-pin), USB port

Cautions during Use

- Follow instructions in 'Cautions during Use'. Otherwise, it may cause unexpected accidents.
- Check the polarity of the terminals before wiring the temperature sensor.
- For RTD temperature sensor, wire it as 3-wire type, using cables in same thickness and length. For thermocouple (CT) temperature sensor, use the designated compensation wire for extending wire.
- Keep away from high voltage lines or power lines to prevent inductive noise. In case installing power line and input signal line closely, use line filter or varistor at power line and shielded wire at input signal line.
- Do not use near the equipment which generates strong magnetic force or high frequency noise.
- Do not apply excessive power when connecting or disconnecting the connectors of the product.
- Install a power switch or circuit breaker in the easily accessible place for supplying or disconnecting the power.
- Do not use the unit for other purpose (e.g. voltmeter, ammeter), but temperature controller.
- When changing the input sensor, turn off the power first before changing.
- After changing the input sensor, modify the value of the corresponding parameter.
- 24VAC, 24-48VDC power supply should be insulated and limited voltage/current or Class 2, SELV power supply device.
- Do not overlapping communication line and power line.
- Use twisted pair wire for communication line and connect ferrite bead at each end of line to reduce the effect of external noise.
- Make a required space around the unit for radiation of heat.
- For accurate temperature measurement, warm up the unit over 20 min after turning on the power.
- Make sure that power supply voltage reaches to the rated voltage within 2 sec after supplying power.
- Do not wire to terminals which are not used.
- This unit may be used in the following environments.
 - ①Indoors (in the environment condition rated in 'Specifications')
 - ②Altitude max. 2,000m
 - ③Pollution degree 2
 - ④Installation category II

Major Products

- Photodiode Sensors
- Fiber Optic Sensors
- Door Sensors
- Door Side Sensors
- Area Sensors
- Proximity Sensors
- Pressure Sensors
- Rotary Encoders
- Connector/Sockets
- Switching Mode Power Supplies
- Control Switches/Lamps/Buttons
- I/O Terminal Blocks & Cables
- Stepper Motors/Drivers/Motion Controllers
- Graphic/Logic Panels
- Field Network Devices
- Laser Marking System (Fiber, CO₂, Nd:YAG)
- Laser Welding/Cutting System
- Temperature Controllers
- Temperature/Humidity Transducers
- SSRs/Power Controllers
- Counters
- Timers
- Panel Meters
- Tachometer/Pulse (Rate) Meters
- Display Units
- Sensor Controllers

Autonics corporation
<http://www.autonics.com>

■ HEADQUARTERS:
 18, Bansong-ro 513beon-gil, Haendae-gu, Busan, South Korea, 48002
 TEL: 82-51-519-3232
 E-mail: sales@autonics.com

DRW170598AB